



Design built **Three-sided Digital KIOSKS** product information

Savannah International Airport



Open frame monitor

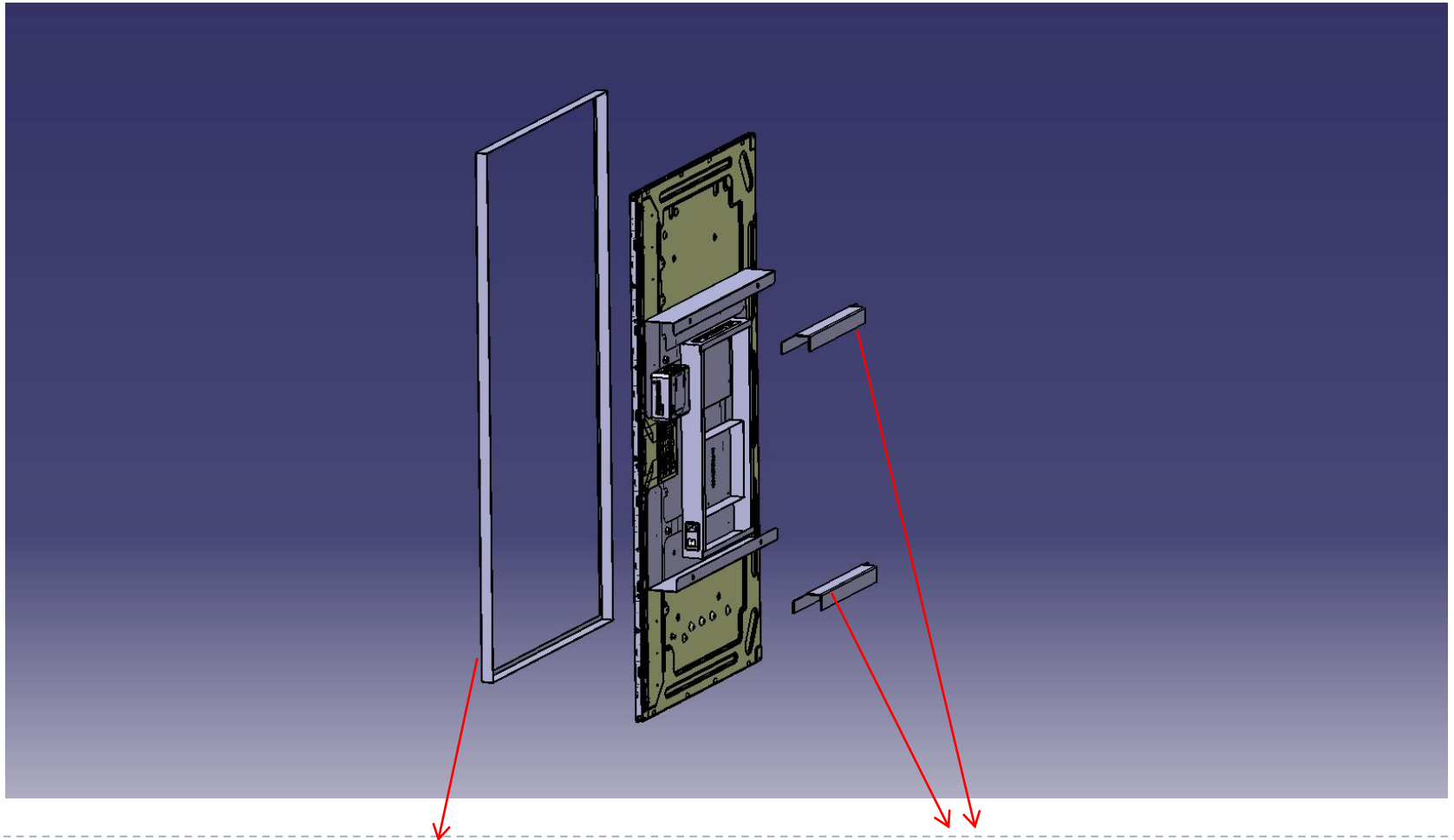

Stainless steel cover

Monitor hanger bracket

Specification

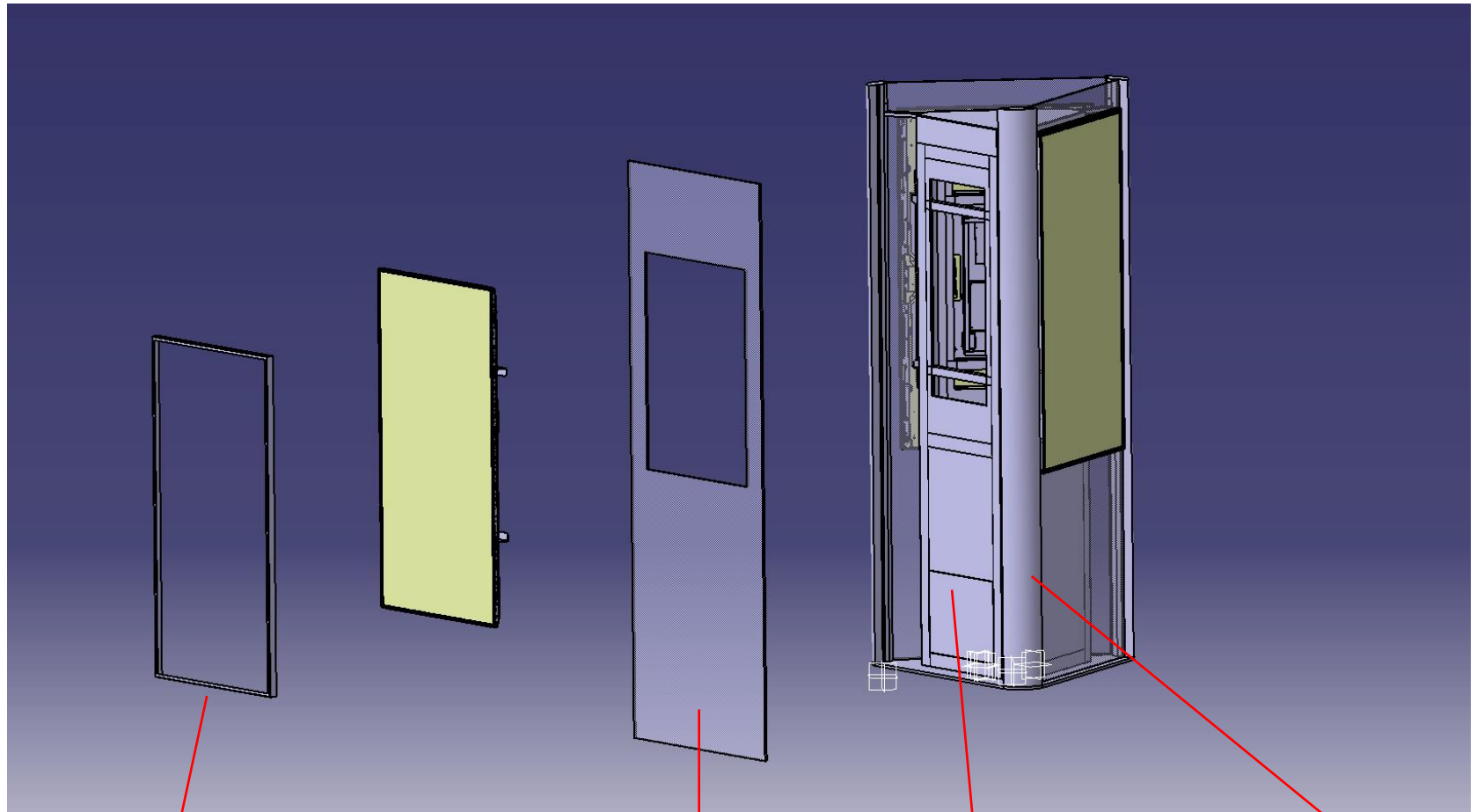

▶ Stainless steel 304 series Polycarbonate CR(cold rolled Steel) Aluminum

Specification

Nanov Model Number		NBDO550PC
Screen	Size (Diagonal)	55inch TFT-LCD panel
	Orientation	Portrait
	Resolution	1920 x 1080 pixels
	Brightness	450 cd/m ²
	Contrast ratio	4000:1
	Viewing angles	178° / 178° (Horizontal / Vertical)
Housing	Materials	Powder coated NCT metal housing
		w/o Tempered glass - Option
Embedded PC		5i3RYH(i3-5010U, 2.10GHz, MAX 16GB Memory, M.2 SSD&2.5"HD D/SSD, HD Graphics 5500
Input panel		AC Power x 1, HDMI x 1
Power consumption (Typical)		300Watt, Free voltage(AC85V ~AC243V)
Overall Physical Dimensions (W x D x H)		1249 x 720 x 100mm
Weight per Unit		approx. 45Kg
Ventilation		Internal FANs
Operating Temperature		0°C ~ 45°C
Operating Humidity		10% ~ 85%
Mount		VESA hole / 600 * 400 mm
M.O.Q		100 units

55" Three-sided KIOSKS Dimension

NMST-55P-SAV : Savannah Airport model

NMST-SAVCUS

NBD550PC

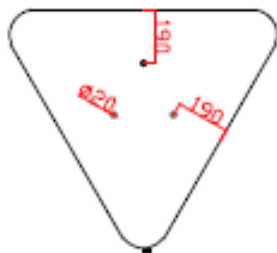
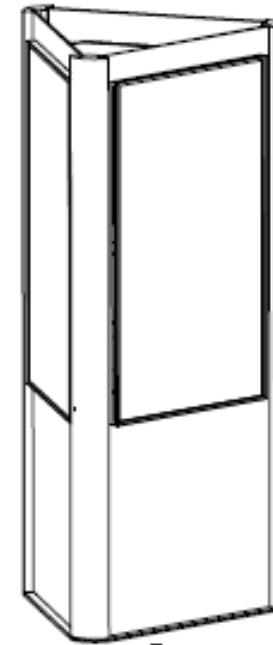
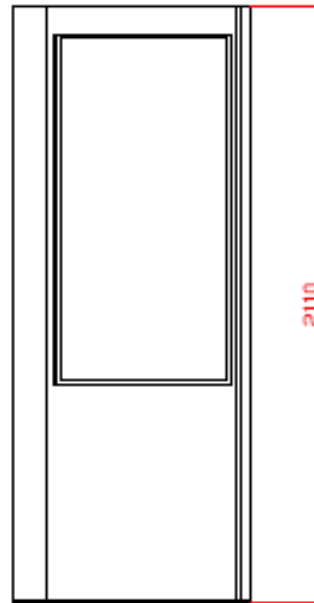
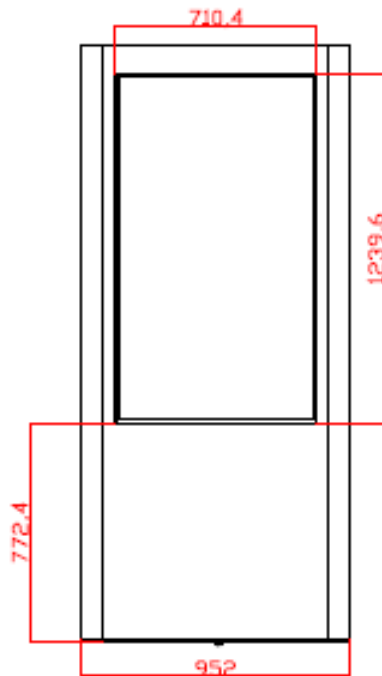
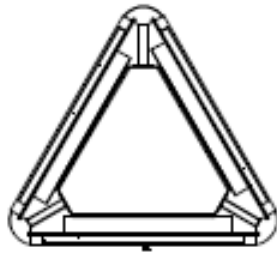

55" Three-sided KIOSKS concept



55" Three-sided KIOSKS After Installation

